

# NFC-H Condensing High Capacity Fire Tube Combi-boilers

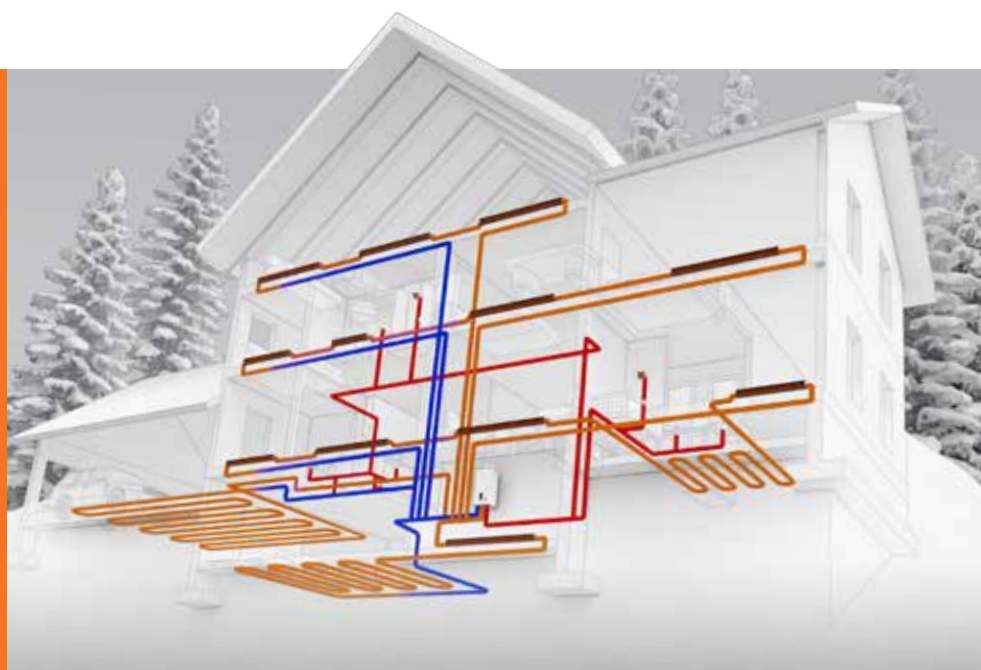

The highest selling combi-boiler brand goes even higher with whole house heating and DHW

NaviLink® Wi-Fi remote control system...available as an add-on accessory.



# NFC-H NAVIEN FIRE TUBE CONDENSING HIGH CAPACITY COMBI-BOILERS

Highest heating and DHW performance ever built into one compact combi-boiler

Navien innovation, durability and proven fire tube technology has done it again. The new NFC-H has more heating and DHW capacities for today's larger progressive homes. Navien continues to reinvent smarter ways to bring high efficiency home comfort to your customers. Also, Navien continues to make installation and set-up easier for contractors.



**PATENTED  
STAINLESS STEEL  
HX FOR HEATING**

**SEPARATE  
HIGHER FLOW  
DHW HX**

**ADVANCED  
USER INTERFACE**

**TDR UP TO  
15:1 HTG  
DHW**

**NG OR LP FIELD GAS  
CONVERTIBLE**

**3 ZONES  
VALVES or PUMPS**

**2" VENT UP TO  
65 FEET & 3" VENT  
UP TO  
150 FEET**

**1/2" GAS CAPABILITY  
UP TO  
24 FT**

**ENERGY STAR  
AFUE  
95.0%**

T H E L E A D E R I N C O N D E N S I N G T E C H N O L O G Y



## Navien takes high efficiency fire tube combi technology to new heights

- **Highest** DHW maximum BTU/H in residential combi-boilers... 210,000 per hour
- **Highest** DHW flow rate @ 70°F rise... up to 5.4 GPM
- **Highest** residential combi DHW 15:1 TDR
- **Highest** residential combi heating TDR... up to 15:1\*
- **Highest** full lineup 2" venting lengths... up to 65 feet
- **Highest** number of built-in zone pump or zone valve connections: 3
- **Highest** number of cascade capable units with NPE tankless water heaters... up to 15
- **High altitude certification...** up to 10,100 feet (NG or LP)

\*Based on NFC-250/200H.



**HEATING UP TO 199,900 BTU/h**  
**DHW 210,000 BTU/h**

 **navien**

# COMPARE THESE ADVANTAGES AND SEE WHY NFC-H COMBI'S ARE THE RIGHT FIT FOR SMALL AND LARGE HOMES

## Patented stainless steel fire tube heat exchanger

Navien's advanced patented stainless steel heat exchanger design is ASME-Certified, "H" Stamped, and reduces high stress point weld failures common on other combi-boilers. This compact, in-house designed and manufactured heat exchanger uses the latest automated laser welding technology to deliver superior product quality.

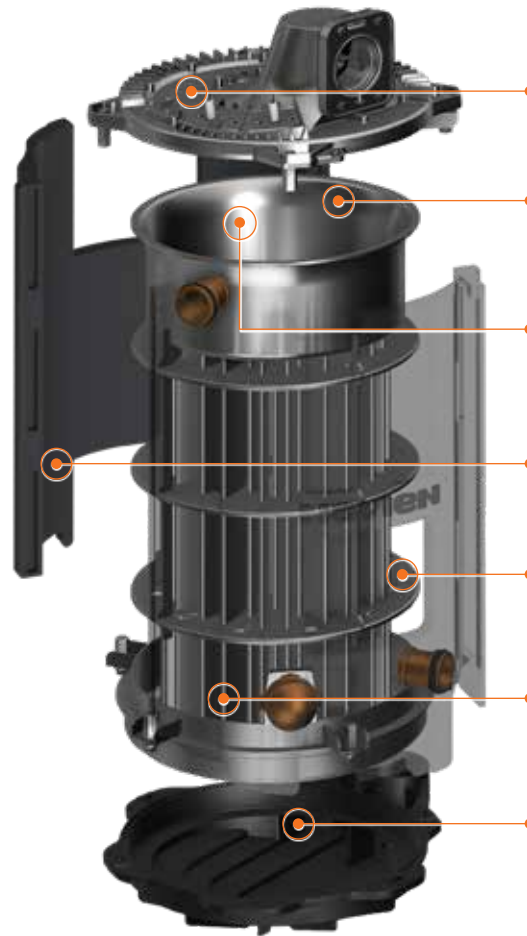

- **Low profile burner design** is easy to remove, improving serviceability. It also reduces overall heat exchanger height
- **One-piece combustion chamber** minimizes welding point areas prone to corrosion
- **Innovative heat exchanger design** allows water to fill the entire heat exchanger eliminating extra insulation at the top of the combustion chamber and improves durability
- **EPP insulation** used on the heat exchanger exterior reduces heat loss and increases efficiency
- **New heat exchanger diaphragm design** optimizes water flow and performance
- **Turbulators inside the tubes** increase structural strength and create a cyclone effect of flue gases maximizing heat transfer rate and efficiency
- **Non-metallic drain pan** prevents corrosion caused by acidic condensate

## Built-in DHW module now with advanced performance

Navien's new innovative domestic hot water heat exchanger now generates even more hot water, giving customers the ability to run up to 3 showers and a dishwasher, all at the same time with up to 5.4 gallons per minute at a 70°F temperature rise.



**Separate stainless steel flat plate heat exchanger** for DHW creates one of the highest flow rates for combi-boilers in the industry. Up to 5.4 GPM @ 70°F temperature rise.

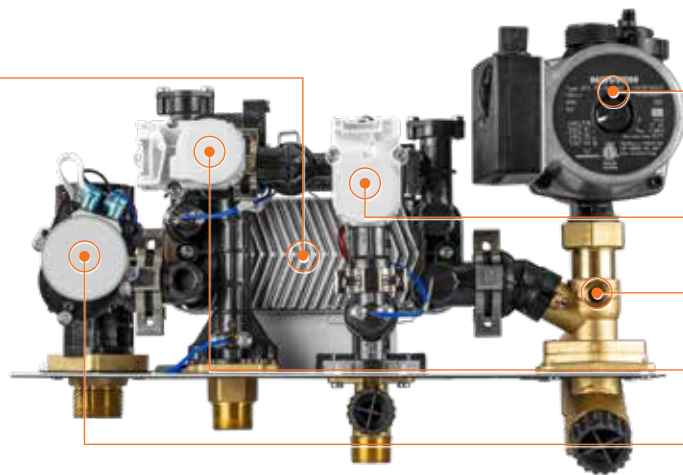

- **Integrated boiler pump** for hydronic space heating and domestic hot water. No need for an external pump saving installation time, space and costs
- **New flow adjustment valve**
- **Water feed valve**
- **New mixing valve**
- **New easy access 3-way valve**

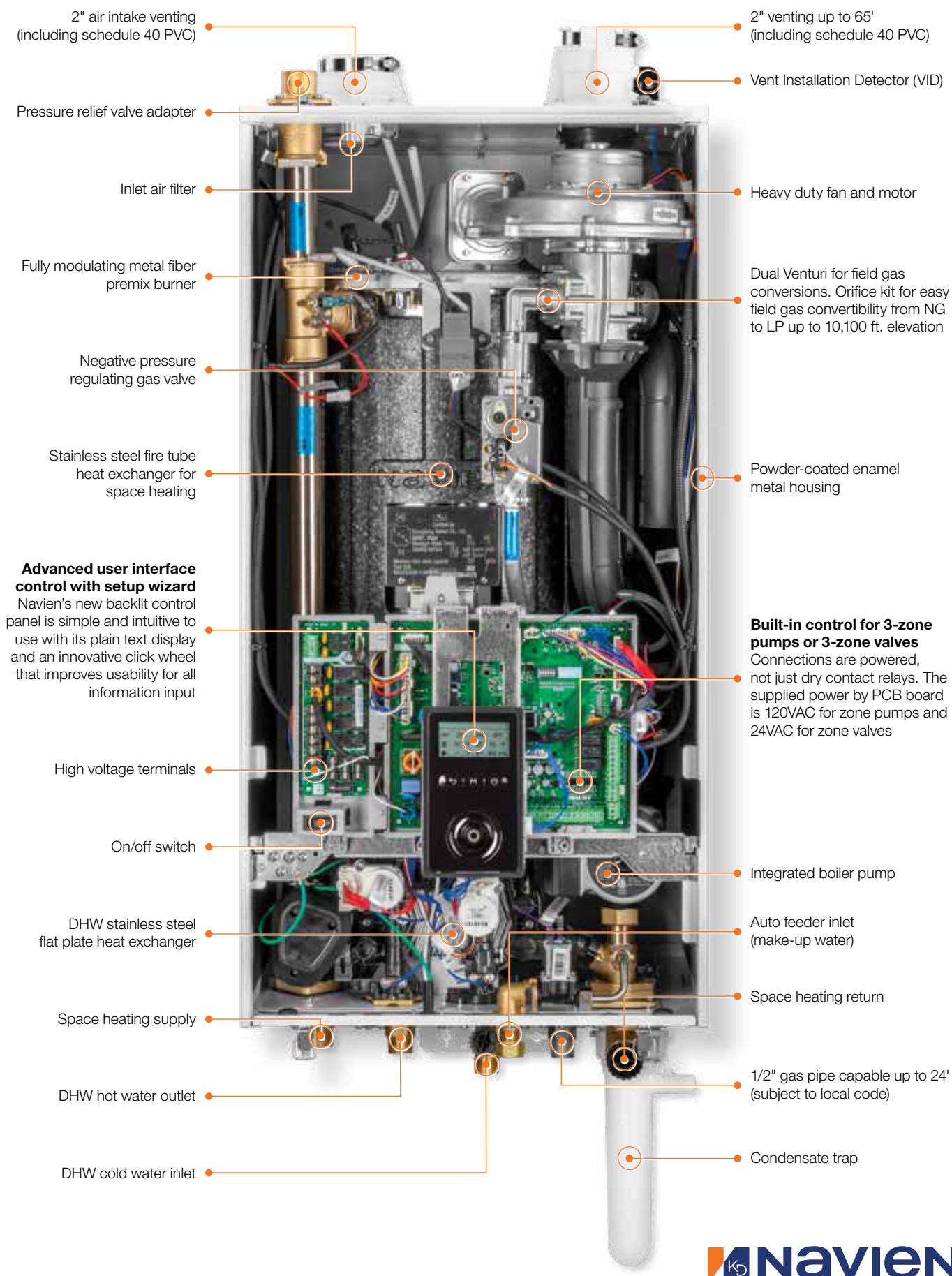

2" air intake venting  
(including schedule 40 PVC)

2" venting up to 65'  
(including schedule 40 PVC)

Pressure relief valve adapter

Vent Installation Detector (VID)

Inlet air filter

Heavy duty fan and motor

Fully modulating metal fiber  
premix burner

Dual Venturi for field gas  
conversions. Orifice kit for easy  
field gas convertibility from NG  
to LP up to 10,100 ft. elevation

Negative pressure  
regulating gas valve

Stainless steel fire tube  
heat exchanger for  
space heating

Powder-coated enamel  
metal housing

**Advanced user interface  
control with setup wizard**

Navien's new backlit control  
panel is simple and intuitive to  
use with its plain text display  
and an innovative click wheel  
that improves usability for all  
information input

**Built-in control for 3-zone  
pumps or 3-zone valves**

Connections are powered,  
not just dry contact relays. The  
supplied power by PCB board  
is 120VAC for zone pumps and  
24VAC for zone valves

High voltage terminals

On/off switch

Integrated boiler pump

DHW stainless steel  
flat plate heat exchanger

Auto feeder inlet  
(make-up water)

Space heating supply

Space heating return

DHW hot water outlet

1/2" gas pipe capable up to 24'  
(subject to local code)

DHW cold water inlet

Condensate trap

# MORE REASONS TO CHOOSE NFC-H FOR THE BEST ALL-IN-ONE HOT WATER SYSTEM



## Dual inputs of 210,000 BTU/H for DHW and up to 199,900 BTU/H for heating

Satisfies all the space heating and domestic hot water requirements of most typical large homes.



## Space saving and light weight design

Navien's sleek wall-hung combi-boilers occupy 80% less space than traditional floor standing boilers and tank water heaters.

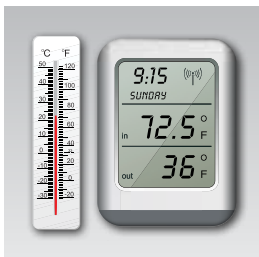

## TDR up to 15:1 for heating and for DHW

The sophisticated gas flow control system provides a high turndown ratio, reducing energy waste and excessive boiler cycling and enhances temperature control for DHW.



## Low noise levels

Installations in or near media rooms, recreation rooms or any living areas of the house are possible with the quiet running NFC-H combi-boilers.



## 2" PVC venting and 1/2" gas pipe capability

Save time and effort in retrofit application with 2" PVC venting up to 65' or up to 150' with 3" venting. 1/2" gas lines for up to 24' also speeds up installations.



## Expanded DHW capability

For increased domestic hot water flow demand, the NFC-H can be cascaded with up to 15 NPE-2 tankless water heaters.

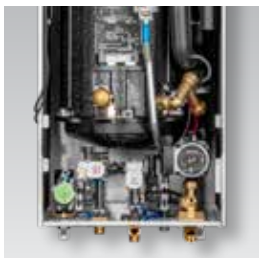

## Easy access to DHW module and valves

All components of DHW module including water feed valve, flow adjustment valve, mixing valve and cartridge-style 3-way valve are right behind circuit board for easy serviceability.

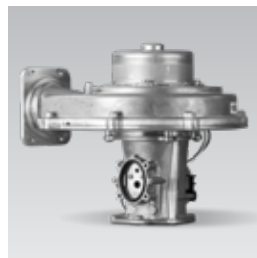

## Dual Venturi and field gas convertibility

Dual Venturi system creates better combustion control and turndown ratio. Field gas convertibility is easy with orifice conversion kits for NG high altitude (5,400–10,100 ft.) and LP (up to 10,100 ft.) included with NFC-H Series combi-boilers.



# NFC-H combi-boiler accessories



## NaviLink®

### Wi-Fi control

This add-on accessory will enable customers with smartphones and tablets to control temperatures remotely, access usage data and receive diagnostic notifications on NFC-H models.

PBCM-AS-001



## NaviLink<sup>Lite</sup>™

### Wi-Fi control

This add-on accessory will enable customers with smartphones and tablets to control temperatures remotely, access usage data and receive diagnostic notifications on all Navien products.

PBCM-AS-002



## HotButton®

### DHW activation

At the push of a button, the HotButton® hot water system activates the DHW heat exchanger to heat water in the supply lines to provide hot water only when it's needed.

PZZZ-00046



## NaviClean<sup>Powered by ADEY</sup>

### Magnetic filtration system

Removes higher levels of iron oxides, sludge and debris with powerful magnetic filter.

GXXX001727



## PeakFlow<sup>S</sup>

### Scale prevention system

GPWC110001AC001

### PeakFlow<sup>S</sup> replacement filter

GWFC110GD001



## SmartZone<sup>+</sup>

### Pump controller

Allows control from 4 to 6 zone pumps and expansion of built-in NFC-H zoning.

2 Zones: PFMZ-02P-001

3 Zones: PFMZ-03P-001

4 Zones: PFMZ-04P-001

6 Zones: PFMZ-06P-001



## NaviCirc™

### Recirculation valve

NaviCirc™

PFFW-SXX-001

NaviCirc™ kit

30022965A



## Combi-boiler primary manifold kit

This package includes new stainless steel manifold, system-matched isolation valves and PRV-air vent adapter.

30026576B



## Common vent collar kit

Required for common venting the NFC-H with NPE tankless water heaters.

30014367B

Includes common vent collar damper, VID jumper cable and cascade cable. (GXXX000546)



## Commercial neutralizer

Commercial condensate neutralizer for up to 16 units (1 NFC-H and up to 15 NPE's).

GXXX001325

### Commercial replacement media

GXXX001329

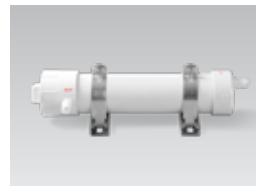

## Light commercial neutralizer

Light commercial condensate neutralizer for up to 6 units (1 NFC-H and up to 5 NPE's).

GXXX001324

### Lt. commercial replacement media

GXXX001328



## Residential neutralizer (V2)

Residential condensate neutralizer for NFC-H series units designed to neutralize the condensate of one unit.

GXXX002212

### Residential replacement media

GXXX001323



## Cascade cable

Up to 15 NPE-A/S tankless water heaters.

GXXX000546



## Universal temperature sensor

Designed to sense supply, return or tank water temperature. Works with all NFC-H series combi-boilers.

GXXX001769



## Ready-Link<sup>®</sup> rack base (V3) and add-on rack(s)

### Base (V3)

GFFMKDIZUS-005

### Add-on (V3)

GFFMKDIZUS-006

# Dimensions

# Ratings & specifications

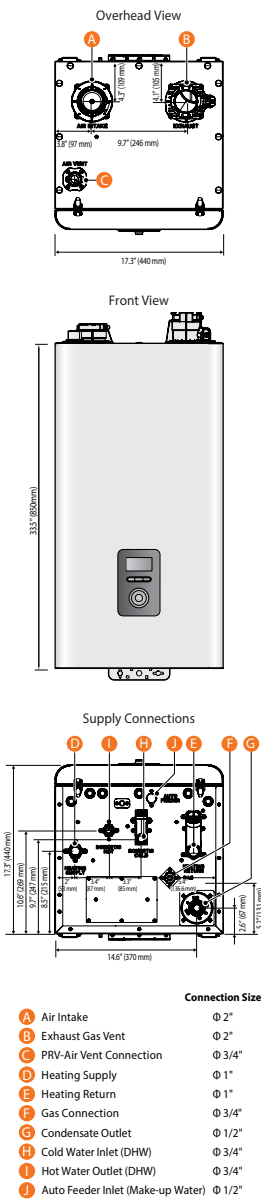

Navien Combination Condensing Boiler Space Heating Ratings					Other Space Heating Specifications			
Model Number <sup>1</sup>	Heating Input (BTU/H)		Heating Capacity <sup>2</sup> (BTU/H)	Net AHR Rating Water <sup>3</sup> (BTU/H)	AFUE <sup>2</sup> %	Water Pressure	Water Connection Size (Supply, Return)	Water Volume
	Min	Max						
NFC-250/175H	13,300	175,000	161,000	140,000	95.0	12–80 psi	1" NPT	4.5 gallons
NFC-250/200H	13,300	199,900	183,000	159,000	95.0			

<sup>1</sup>Ratings are the same for natural gas models converted to propane use.

<sup>2</sup>Based on U.S. Department of Energy (DOE) test procedures.

<sup>3</sup>The net AHRI water ratings shown are based on a piping and pickup allowance of 1.15.

Consult Navien before selecting a boiler for installations having unusual piping and pickup requirements, such as intermittent system operation, extensive piping systems, etc.

Navien Combination Condensing Boiler Domestic Hot Water Ratings			Other Domestic Hot Water Specifications				
Model Number	Input Ratings (BTU/H)		Water Pressure PSI	Minimum Flow Rate GPM (L/m)	Flow Rate 45°F (25°C) Temp Rise GPM (L/m)	DHW Supply Connection Size	
	Min	Max				Supply	Return
NFC-250/175H	13,300	210,000	15–150	0.5 (1.9)	7.9 (30.0)	3/4" NPT	3/4" NPT
NFC-250/200H							

Item	Model	
	NFC-250/175H	NFC-250/200H
Dimensions	17.3" W x 17.3" D x 33.5" H	
Boiler weight	141 lb (64 kg)	
Boiler weight with water	170 lb (77 kg)	
Installation type	Indoor wall-hung	
Venting type	Forced draft direct vent	
Ignition	Electronic ignition	
Natural gas supply pressure (from source)	3.5" to 10.5" WC	
Propane gas supply pressure (from source)	8.0" to 13.5" WC	
Natural gas manifold pressure	-0.03" to -0.92" WC	
Propane gas manifold pressure	-0.02" to -0.77" WC	
Gas connection size	3/4" NPT	
Power supply	Main supply	120V AC, 60Hz
	Maximum power consumption	Less than 15 amperes
Materials	Casing	Cold-rolled carbon steel
	Heat exchanger	Stainless steel
Venting	Exhaust	2" or 3" PVC, CPVC, approved polypropylene 2" or 3" special gas vent type BH (Class III, A/B/C) 2" or 3" stainless steel
	Intake	2" or 3" PVC, CPVC, polypropylene 2" or 3" special gas vent type BH (Class III, A/B/C) 2" or 3" stainless steel
	Vent clearance	0" to combustibles
Safety devices	Flame rod, APS, ignition operation detector, water temperature high limit switch, exhaust temperature high limit sensor, water pressure sensor, burner high limit fuse, vent installation detector (VID)	

NFC-250/175H and NFC-250/200H Series	
Temp. Rise °F (°C)	Flow Rate GPM (L/m) <sup>1</sup>
35 (19)	10.8 (40.9)
40 (22)	9.5 (35.8)
45 (25)	8.4 (31.8)
50 (28)	7.6 (28.6)
55 (31)	6.9 (26.0)
60 (33)	6.3 (23.8)
67 (37)	5.6 (21.4)
70 (39)	5.4 (20.4)
77 (43)	4.9 (18.6)
80 (44)	4.7 (17.9)
85 (47)	4.4 (16.8)
90 (50)	4.2 (15.9)
100 (56)	3.8 (14.3)

<sup>1</sup>Max GPM based on installation conditions.

Navien reserves the right to change specifications at any time without prior notice. Please refer to [www.Navieninc.com](http://www.Navieninc.com) to verify you have the most current information.

## Heating input ranges

Model	Heating (BTU/H)	DHW (BTU/H)
NFC-250/175H	13,300–175,000	13,300–210,000
NFC-250/200H	13,300–199,900	13,300–210,000

## Temperature setting ranges

Item	Temperature Setting Range °F (°C)	Remarks
Space heating	Supply	77–185 (25–85)
	Return	68–158 (20–70)
DHW	86–140 (30–60)	Actual supply and return temperatures vary depending on the selected outdoor reset curve.

## Warranty

Type	Residential*	Commercial
Heat exchanger	10 years	5 years
Parts*	5 years	3 years
Labor	1 year	1 year

\*Applies to single family residential locations.

For complete details please refer to the full warranty at [Navieninc.com](http://Navieninc.com).



Navien Inc., 20 Goodyear, Irvine, CA 92618 800-519-8794 [navieninc.com](http://navieninc.com)

Navien Canada, Inc. 555 Hanlan Rd., Unit 7 Vaughan, ON L4L 4R8 800-519-8794 [navieninc.ca](http://navieninc.ca)



THE LEADER IN CONDENSING TECHNOLOGY